



mhtlighting
illuminating PoE technology



MHTL-VT

LED VAPOR TIGHT SERIES

FEATURES

- 4FT or 8FT Length
- IP65 Wet Location Rated
- Corrosion Proof
- 4kV Surge Protection - Optional 20kV
- 0-10V Dimming Driver

GENERAL INFORMATION

Applications	Building Exterior / Garage / Security Lighting / Walkway
Warranty	10-Year Warranty
Construction	Die Cast Aluminum Housing (Dark Bronze) · Borosilicate Glass Lens or Frosted PC Lens · Ceiling or Wall Surface Mounted · Open Bezel or Closed Eyelid Design
Certifications	 

PRODUCT DATA

Universal Input Voltage	120 - 277V
Optional Input Voltage	347V/480V
Power Factor	> 0.90 @277V
Mounting	Standard Surface Mount
Lumens	7,800 Lumens
Max Input Power	60W
CRI	> 80 - Optional 90 CRI
CCT	2700K/3000K/4000K/5000K
L80	> 100,000 Hours
Rated Lifespan	> 100,000 Hours
THD	< 20% @277V

ORDERING INFO: Sample Code - MHTL-VT-4FT-27K-U-SM-EM

Series	Wattage	Color Temperatures	Input Voltage	Distribution	Options
MHTL-VT					
MHTL-VT	4FT-30 4FT-40 8FT-50 8FT-60	27K=2700K 3K=3000K 4K=4000K 5K=5000K	U=120-277V 347=347V 480=480V	SM=Surface Mount PM=Pendant Mount	(Blank) - Standard in Grey, Custom Color Available EM=Emergency Battery Backup SPD=20kV Surge Protective Device 90CRI=90 CRI

*MHTL-VT-4FT-40E-5K is DLC Listed Product

DIMENSIONS

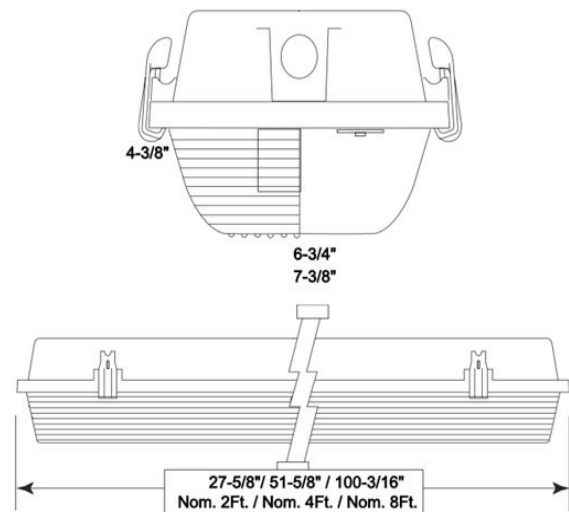

FIXTURE PERFORMANCE

Model	Input Power	Color Temp	Lm/W	Lumens	Dimensions
MHTL-VT-4FT-30E-4K-U	30W	4000K	130	3,900	51.6" x 7.3" x 4.3"
MHTL-VT-4FT-40E-4K-U	40W	4000K	130	5,200	51.6" x 7.3" x 4.3"
MHTL-VT-8FT-50E-4K-U	50W	4000K	130	6,500	100.1" x 7.3" x 4.3"
MHTL-VT-8FT-60E-4K-U	60W	4000K	130	7,800	100.1" x 7.3" x 4.3"